

CRAFTBOX COMFORT

Шкаф - трансформер КОМФОРТ



SYMBOLS



ATTENTION

ВНИМАНИЕ



ASSEMBLY & ADJUSTMENT

СБОРКА РЕГУЛИРОВКА



OPERATION

ЭКСПЛУАТАЦИЯ



STORAGE

ХРАНЕНИЕ

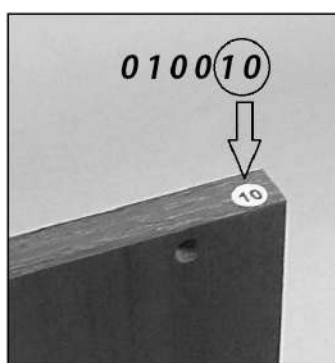

INDICATING MARK

ОБОЗНАЧЕНИЕ

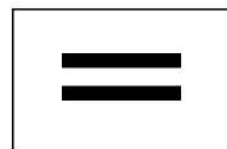

EQUALITY

РАВЕНСТВО

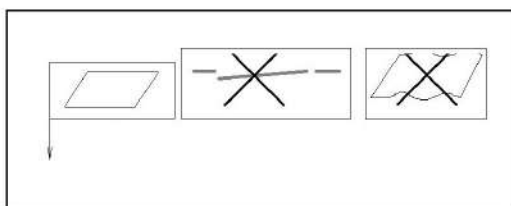

EVEN SURFACE

РОВНАЯ ПОВЕРХНОСТЬ

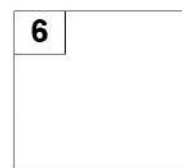

STEP No

НОМЕР ОПЕРАЦИИ

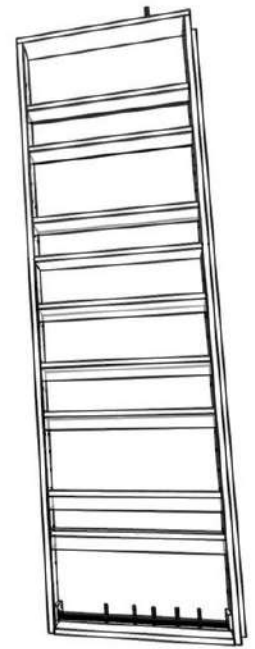

Module A
Модуль А

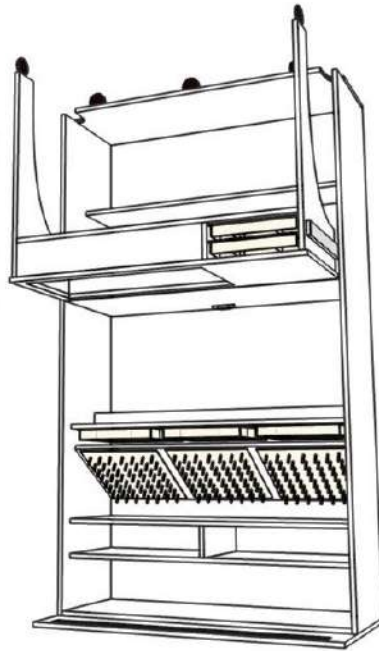

Module D
Модуль D

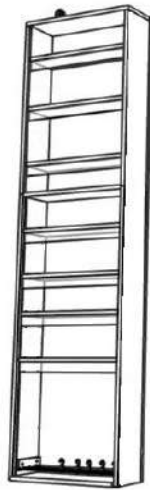

Module B
Модуль B



Module E
Модуль E

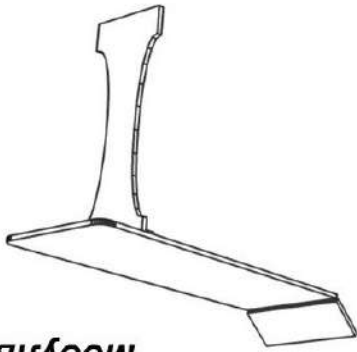

Module C
Модуль C

Mod D



| | | | | | | | |
|--------|----|--------|----|--------|----|--------|----|
| 010001 | 1x | 010003 | 1x | 010004 | 1x | 010006 | 1x |
| 010009 | 1x | 010018 | 1x | 010025 | 1x | 010026 | 1x |
| 010027 | 1x | 010029 | 1x | 010031 | 1x | 010033 | 2x |
| 010034 | 1x | | | | | | |

| | | | | | | |
|--------------|--------------|--------------|--------------|--------------|-----------|-----------|
| 020040 2x | 020041 2x | 020020 2x | 020030 1x | 020047 2x | 4x 020049 | 1x 020012 |
|--------------|--------------|--------------|--------------|--------------|-----------|-----------|

| | | | | | | | |
|---------------------------|---------------------------|--------------------------|--------------------------|---------------------|-------------------------|-----------------------|----------------------|
| 030002 3,5 * 16 24x | 030003 6,2 * 50 41x | 030005 4,2 * 16 4x | 030006 2,9 * 13 2x | 030008 φ 4 2x | 030009 M4 * 20 2x | 030011 φ 15 41x | 030012 φ 18 5x |
|---------------------------|---------------------------|--------------------------|--------------------------|---------------------|-------------------------|-----------------------|----------------------|

| | | | | | |
|----------------------|---------------------------|--------------------------|----------------------|---------------------------|---------------------------|
| 030013 L 35 5x | 030014 φ 15 h 12 5x | 030015 φ 8 * 30 4x | 030022 M 10 4x | 030023 φ 10 S1,8 4x | 030031 φ 10 S2,5 4x |
|----------------------|---------------------------|--------------------------|----------------------|---------------------------|---------------------------|

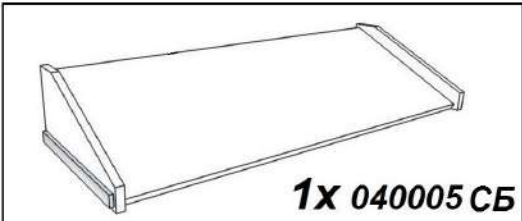

| | |
|-----------|-----------|
| 4x 030029 | 4x 030030 |
|-----------|-----------|

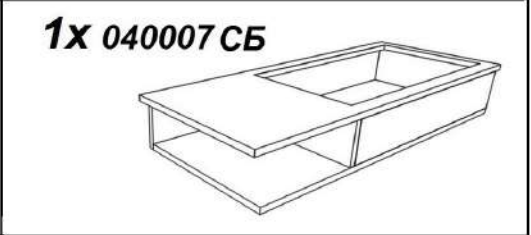
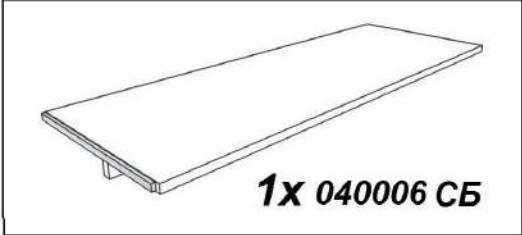











| | |
|-----------|-----------|
| 3x 050004 | 5x 050005 |
|-----------|-----------|



Mod A

040008 СБ







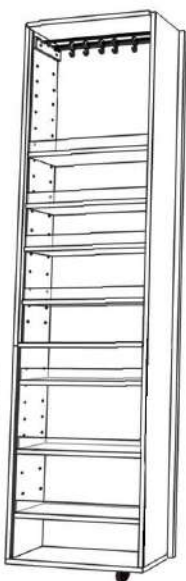

| | | | | | |
|--|--|--|--|--|--|
| 2x 020010  L 660 | | 1x 020038  | 020016 1x  | 020040 1x  | |
| 030002  3,5 * 16 2x | 030008  φ 4 2x | 030009  M4 * 20 2x | 030022  M 10 1x | | |
| 030023  φ 10 S1,8 1x | 030031  φ 10 S2,5 1x | 030038  2,5 * 20 44x | | | |

Mod B

040009 СБ









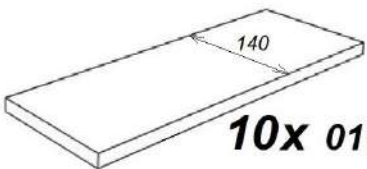
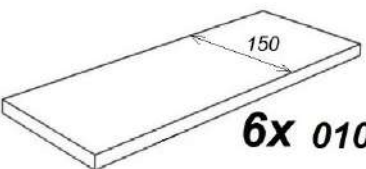

| | | | | | | |
|---|--|--|---|--|--|--|
| 2x 020010  L 660 | | 1x 020038  | 020040 1x  | 1x 020011  | | |
| 030001  3 * 16 2x | 030008  φ 4 2x | 030009  M4 * 20 2x | 030022  M 10 1x | 030023  φ 10 S1,8 1x | 030031  φ 10 S2,5 1x | 030038  2,5 * 20 44x |

Mod A





+



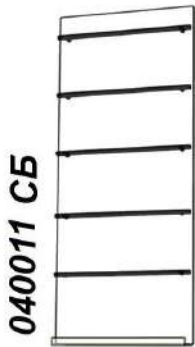

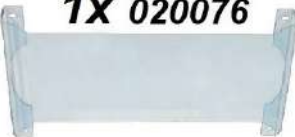

Mod B

| | | | |
|--|---|---|---|
|  10x 010034 | |  6x 010047 | |
| 80x 020020  | 2x 020043  φ 8 L = 455 | 2x 020045  φ 16 L = 455 | |
| 16x 020048  | 020072 10x  | 8x 020077  | 020078 80x  |

Mod E





| | | |
|---|---|---|
|  11x 020072 | 2x 020073  | 1x 020074  |
| 5x 020075  L = 416 | | 1x 020076  |

| | | | | | |
|--|---|--|--|---|--|
| 030004  $\phi 5 * 16$ 4x | 030005  4,2 * 16 4x | 030039  M4 * 16 6x | 030040  $\phi 4$ 6x | 030041  M4 6x | 030043  3,5 * 30 12x |
|--|---|--|--|---|--|

Mod C



| | |
|---|--|
| 030003  6,2 * 50 4x | 030011  $\phi 15$ 4x |
|---|--|



Mod D



- 12x 030011 4
- 12x 030003

- 3x 030011 3
- 3x 030003

- 11 1x 020012
- 2x 030006

- 6 030011
- 13x 030003

- 7 020020
- 2x

- 9 030030
- 4x

- 8 4x 030029

- 1 2x 030022
- 2x 030023
- 2x 020040

- 5 030011
- 7x 030003

- 2 2x 030022
- 2x 030023
- 2x 020041

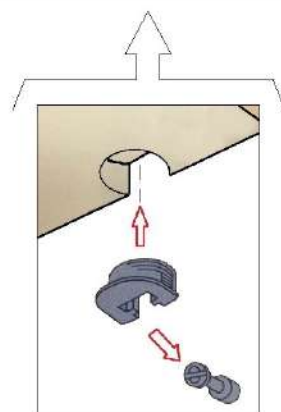
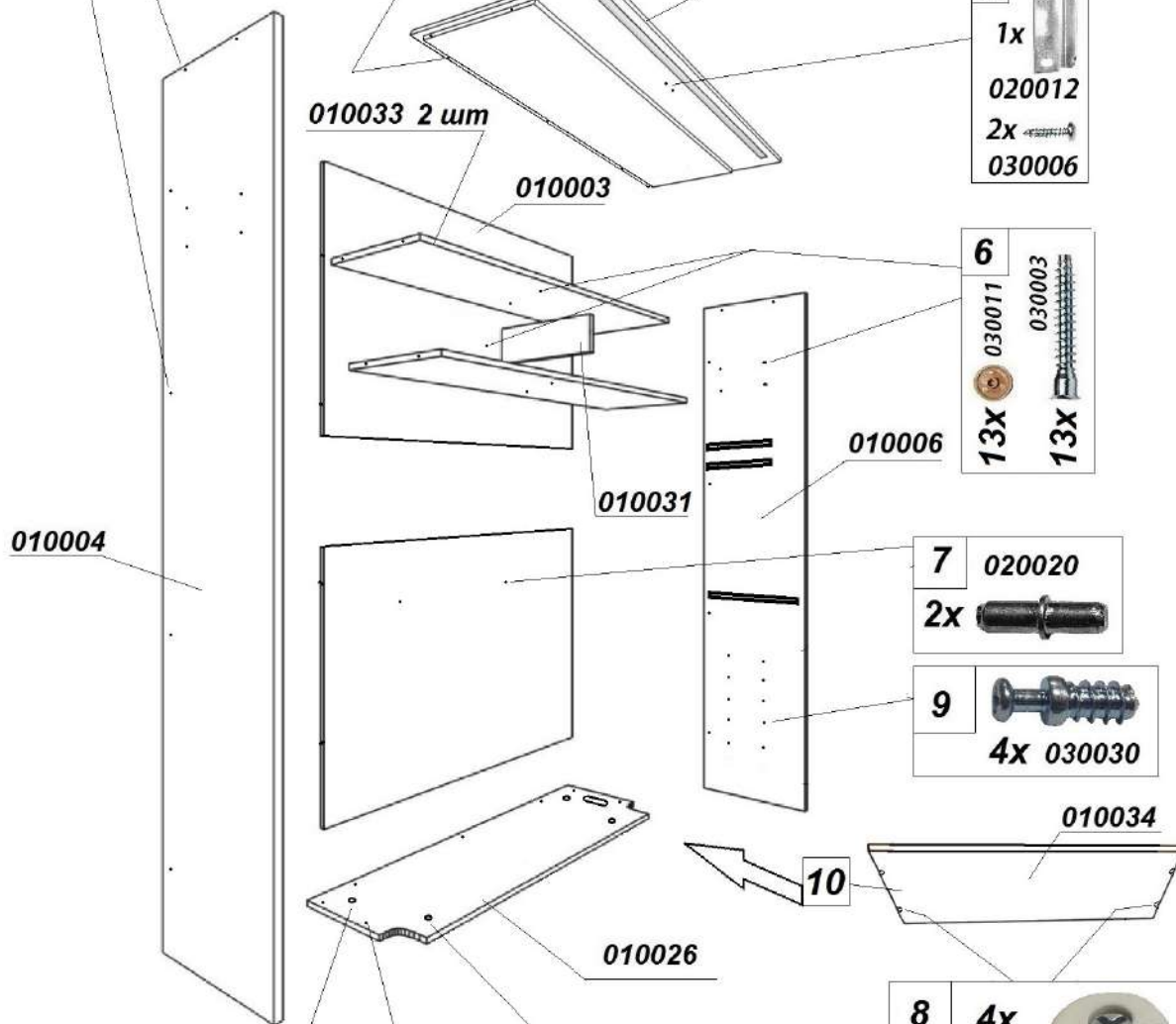



Mod D

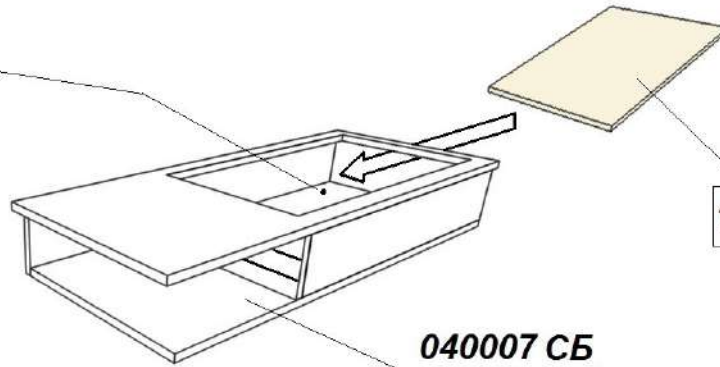

13 010009

040007 CB

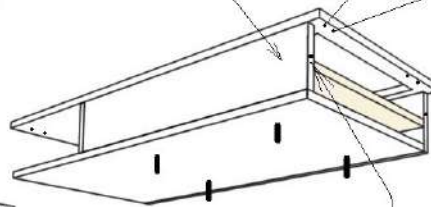
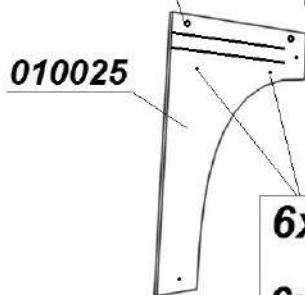
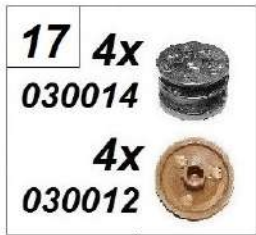

010027

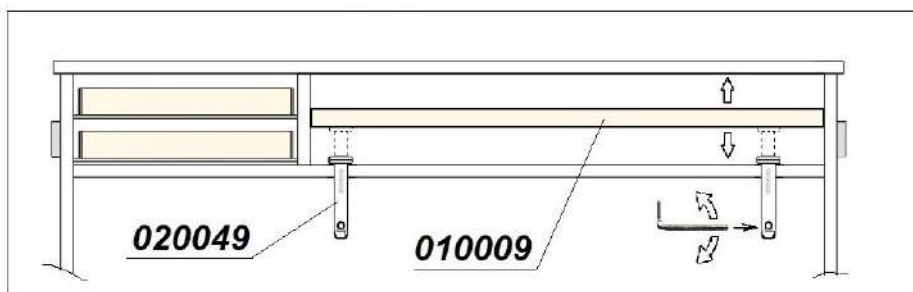
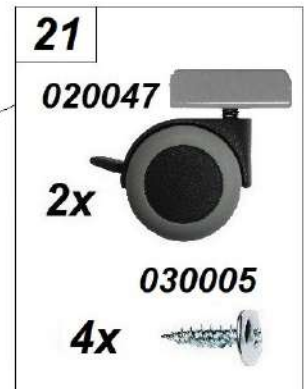



Mod A

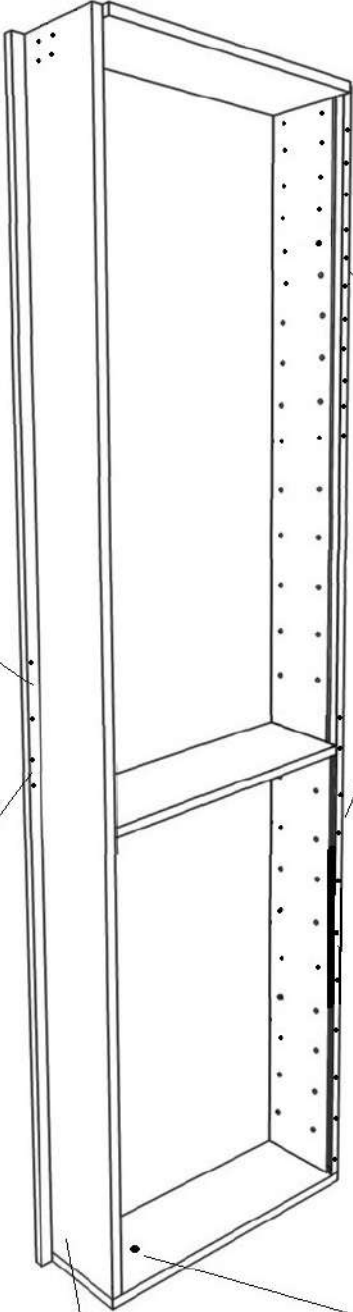

- 26
- 2X 030008 2X 030009
- 1X 020038

- 24
- 22X 030038 2X 020010

- 23
- 1X 020016
- 2X 030002

- 25
- 1X 030022
- 1x
- 1X 030023
- 1X 020040

040008 СБ



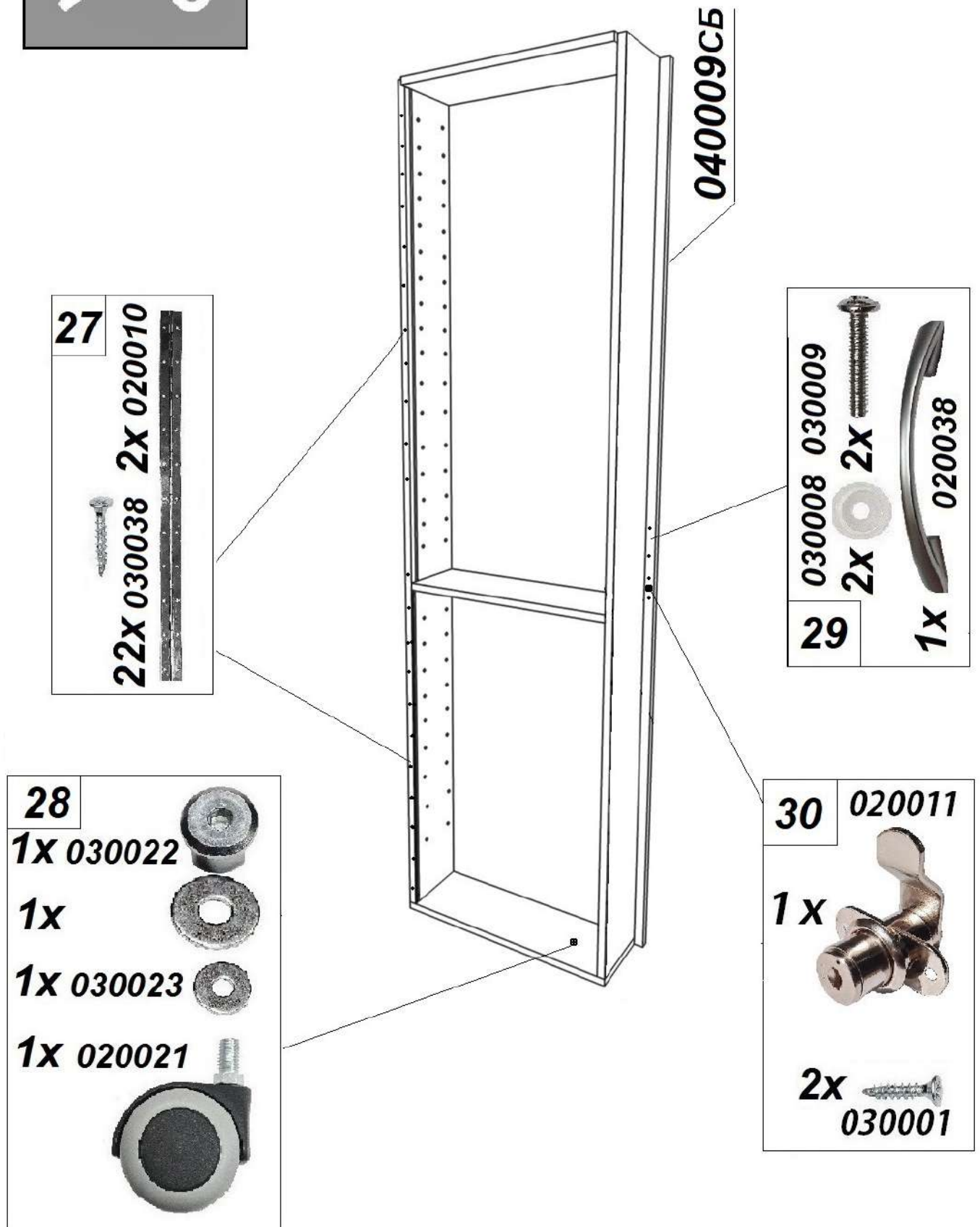

Mod B



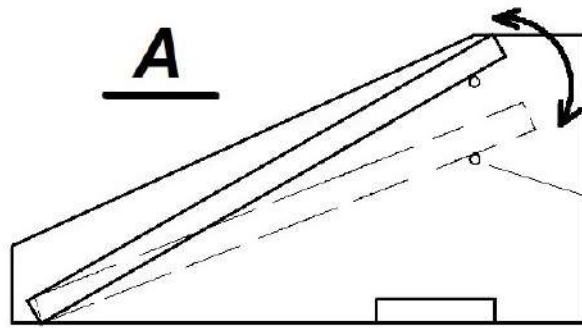

Mod D



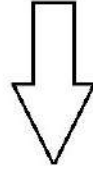

020020

2x

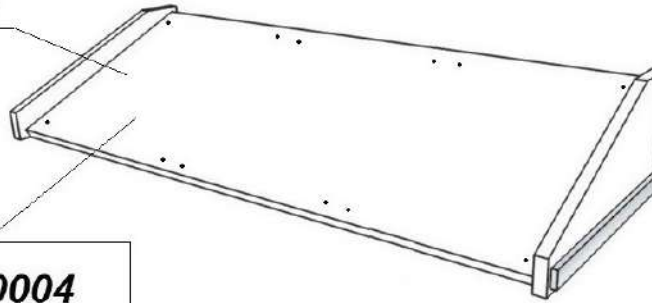

040005 CB







31 **3x 050004**

12x 030002 

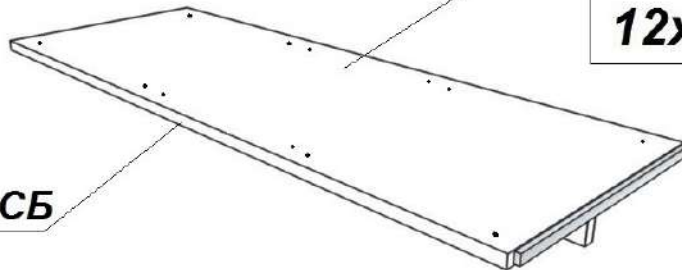
32 **3x 050005**

12x 030002 

040006 CB



33 **1x 020030**

030008 **030009**
2x  **2x** 

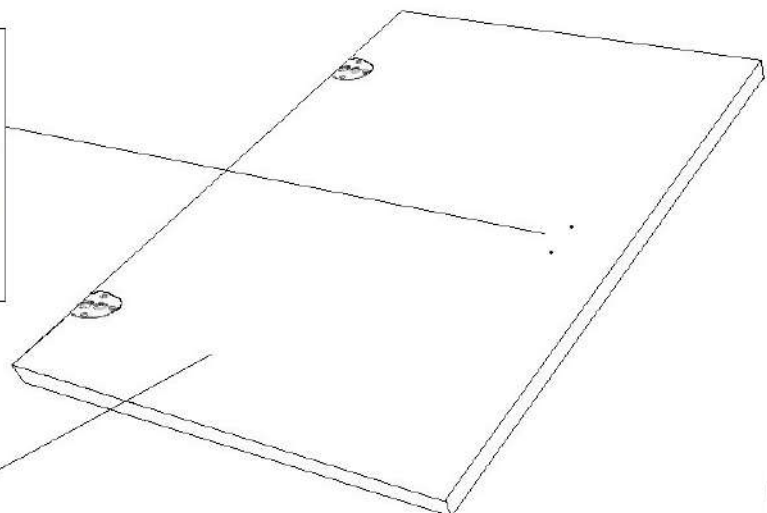
010029

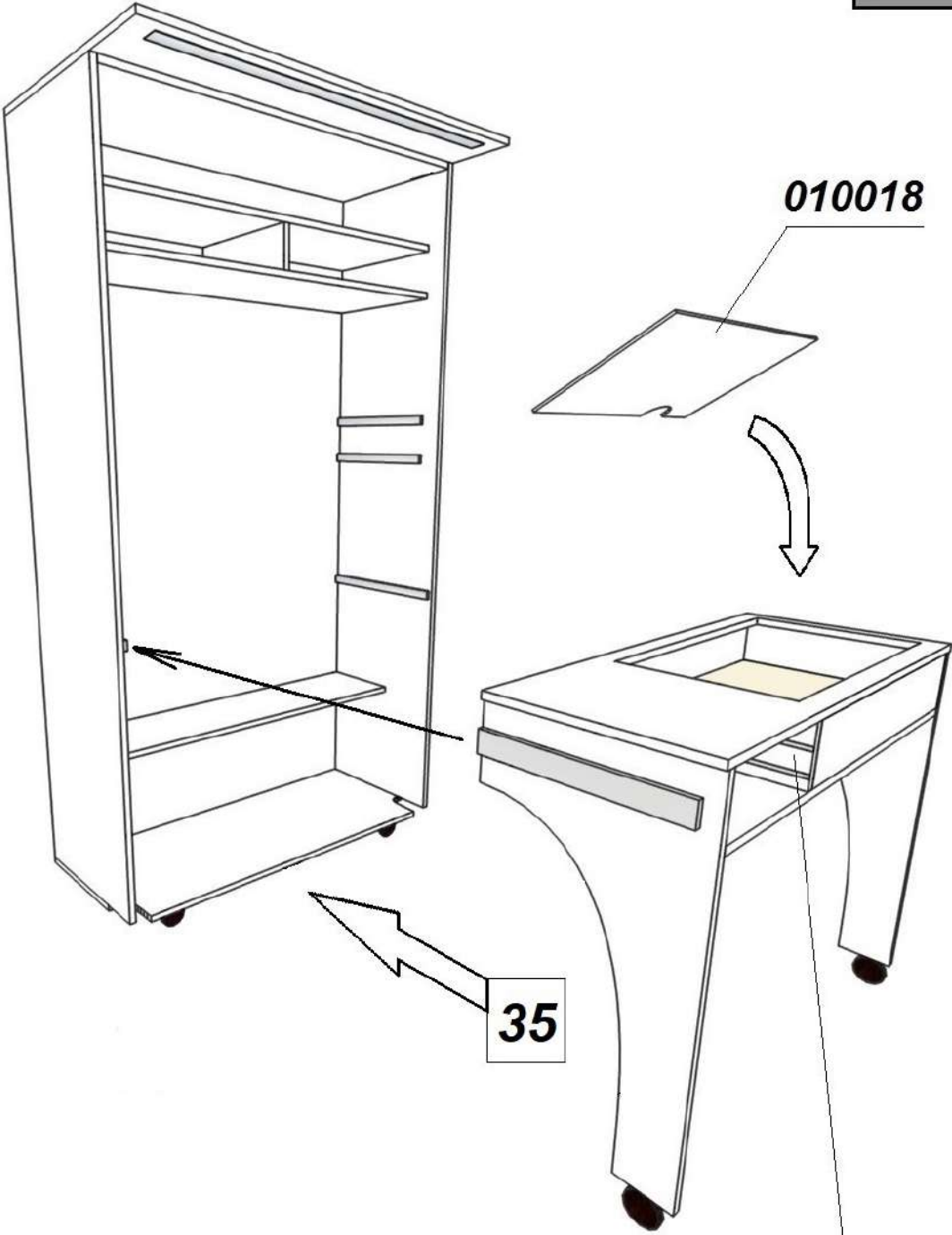

Mod D





Mod D



38

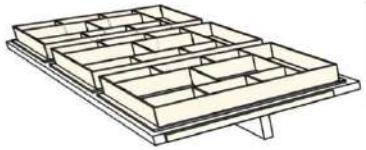

37

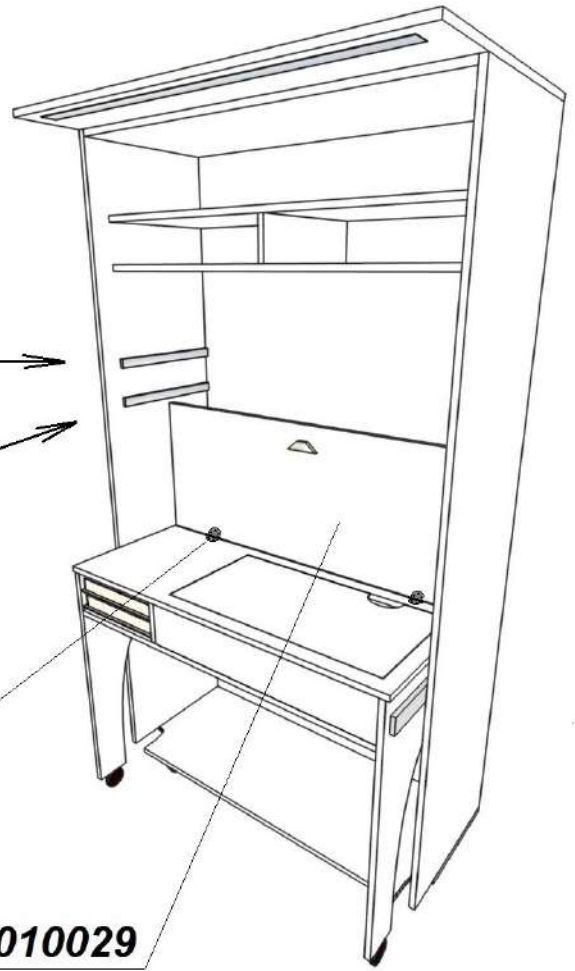

010029

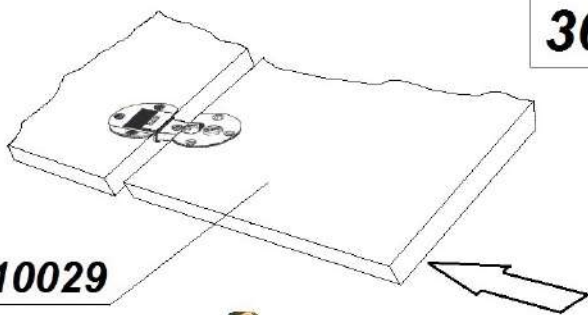

36

010029

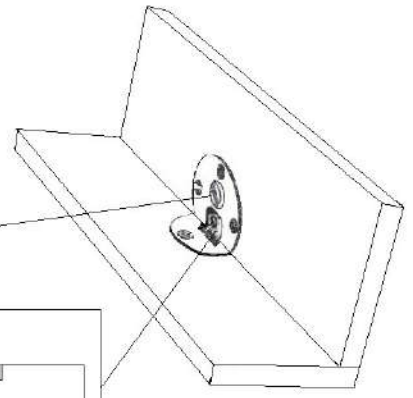
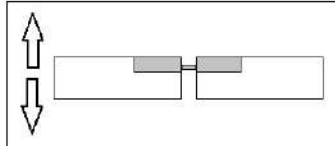
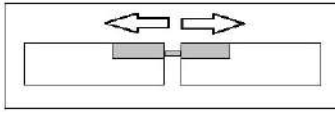
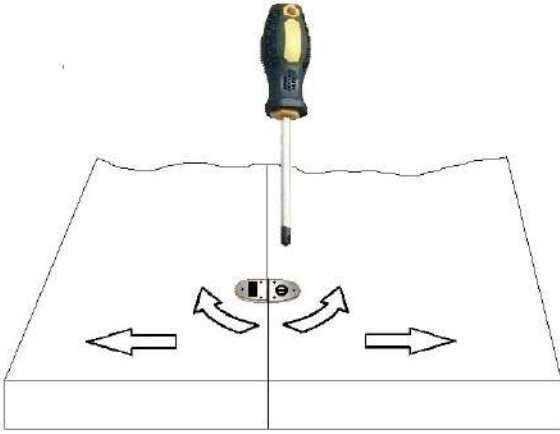

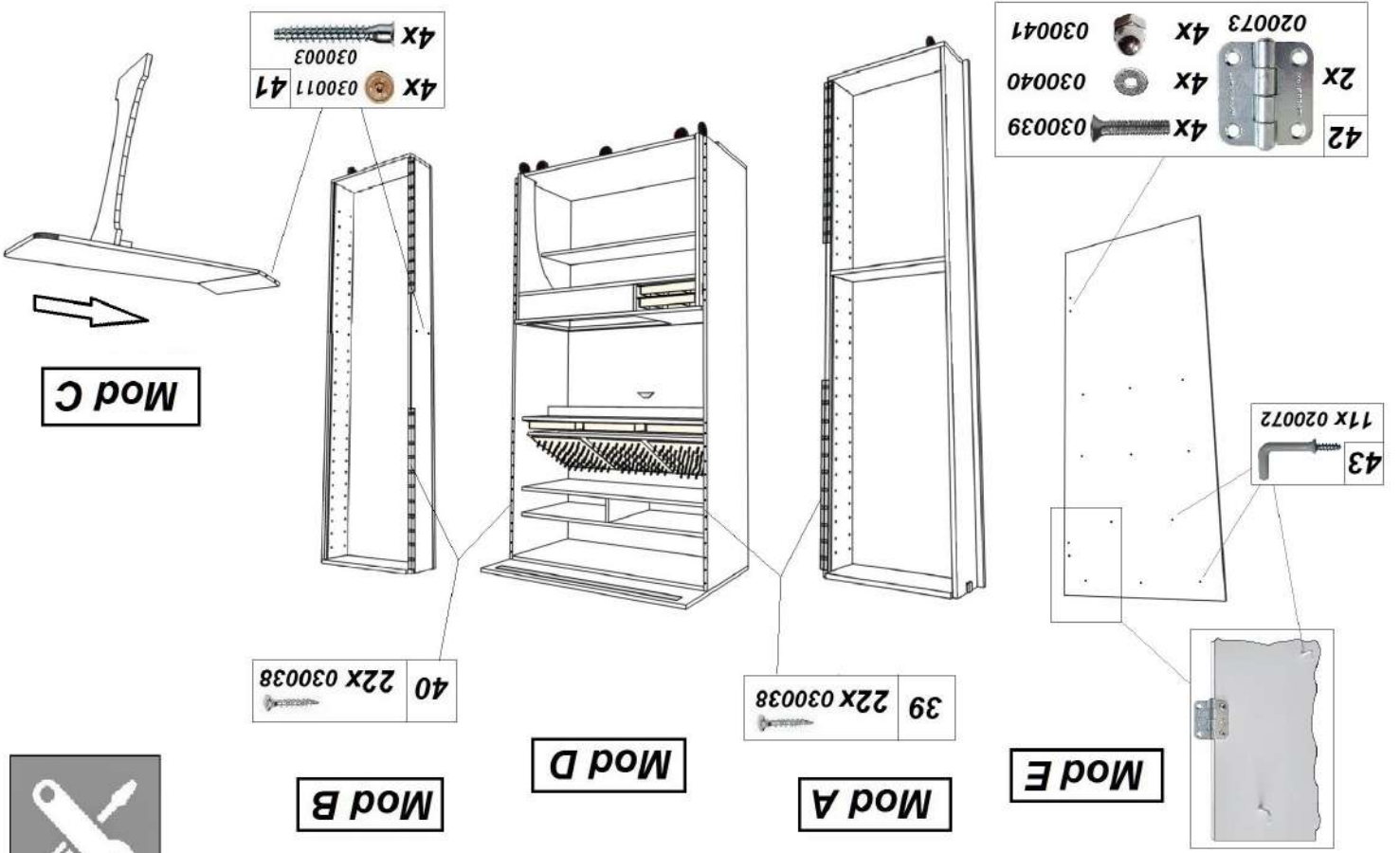







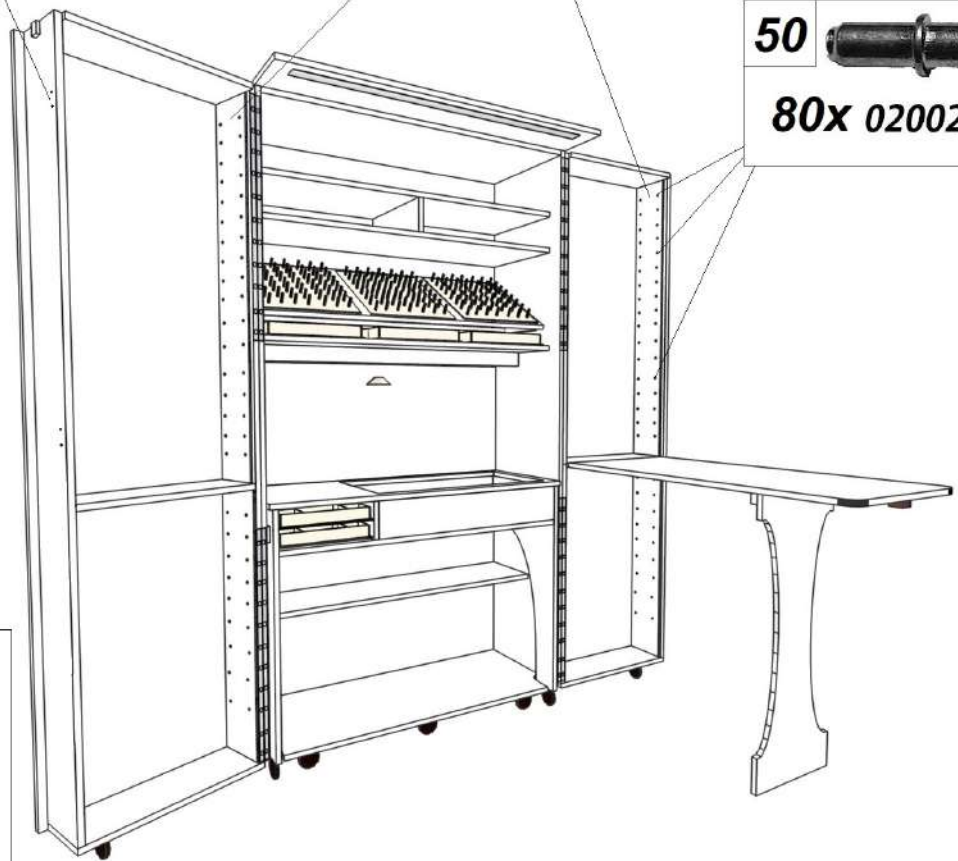
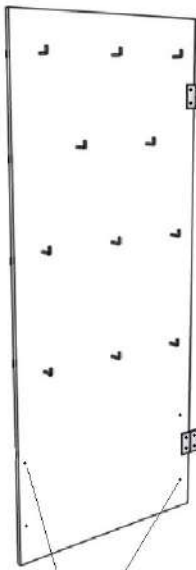

44 030004
4x 

48 8x 020077

50 
80x 020020

A







45 2x 030043

1x 020076

2x  030039
2x  030040
2x  030041

A

 030004
 030041



46 
10x 030043

5x 020075

47 1x 020074

4x  030005

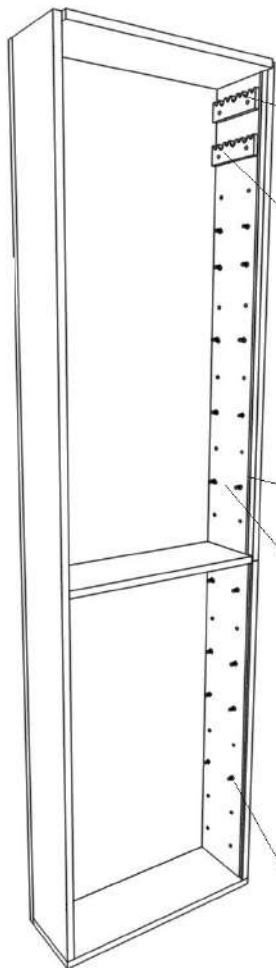

Mod B

Mod A



51 **2X 020043**

52 **2X 020045 10X 020072**

54 **16X 020048**

53 **10X 010034**

55 **80X 020078**

53 **6X 010047**

Mod D

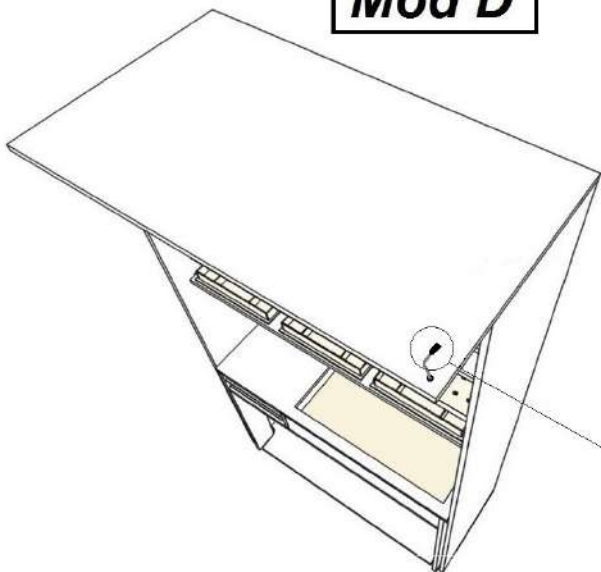

56 **1X 060001**



